



Bistable Power Relay TRK18



- **Coil energizing by DC voltage impulse**
- **Washable version Qc/2**
- **Low coil power consumption**
- **Contact switching current 7A or 10A**
- **UL approval**
- **Ambient temperature up to +70°C**
- **Non-flammable material V-0**
- **Direct instalation on PCB**
- **Plastic bars packing**

TRK 18 is a neutral, bistable, remanent, electromagnetic relay for DC coil energizing with one change - over contact system. The great advantage of the bistable relays over monostable lies in continuous operating without energizing. Bistable relays shall be energized with a brief DC voltage impulse, this saves coil energy and reduces operating costs. The self-heating of this relays no longer needs to be taken into consideration, what also enables high density of electronics components on PC board. Furthermore, if the power supply voltage fails, the switching status is maintained.

As a switching element with ability of galvanic separation it is designed to control devices with medium power consumption. It can be soldered directly onto the printed circuit board used in industry, bureau appliances, data processing, automotive industry, gas heating equipment, safety and medicine devices and for general purposes. In case of full load on contacts and operating with max. switching rate and max. ambient temperature it is recommended to open the vent hole provided for this purpose after the relay is mounted on the PCB and the cleaning process is completed.

Technical data

Operating

The remanent relay has a core with high-retentivity remanence material. When the operating voltage is applied to the coil of relay the remanent core becomes magnetic saturated what causes picking-up the armature and closing the normally-open contact. After the energizing voltage fails, the residual magnetism in the core attracts the armature forward and holds the normaly-open contact closed. When the core is demagnetized with the voltage of opposite polarity, the continual forse of the contact spring releases the relay armature and closes the normally-close contact again. The voltage for demagnetization must be approximately one third as great as the voltage for operating to avoid re-operate of the relay. Connecting of this relay is possible in several different ways, exaples are shown in the drawing of recommended driving circuit.

Contact data

Contact form:	1 Change-over, 1 Make, 1 Break	
Contact material	AgNi10	AgCdO, AgSnO ₂ *
Rated current	7 A	10 A
Max.operating voltage	250 VAC, 60VDC(see diagram)	
Max. switching power:	1750 VA, 170 W	2500 VA, 240 W
Min. switching load	5 VDC, 100 mA	
Contact resistance (New relay)	≤ 100 mΩ 24 V, 100mA	
Max.operating freq. at rated load	600 oper. / h	360 oper. / h
Max.operating freq. at minimal load	36000 operations / h	
Capacitance	< 1.5 pF contact- contact	
Mechanical life	> 2 X 10 ⁷ operations	
Electrical life	CO contact at 70°C see diagram	

*by special agreement

Coil data for energizing at 20°C

Rated power:	0.9 W to 1,4 W
Max. coil temperature:	155° C
Thermal coil resistance:	abt. 115 K/W
Operate voltage:	$U_{op} \leq 75\%U_n$
Nonrelease voltage:	$U_{nr} \geq 3\% (-U_n)$
Release voltage:	$U_{re} \sim 25\% (-U_n)$, max 45% (-U _n)
Operative range:	class 1, IEC 61810 - 1

Coil data for continuous duty

Coil rated voltage	Coil resistance at 20°C	Operative voltage range at 20°C			Release resistor E12/0.5W
		Must operate	U _{max}	Must release	
U _n (VDC)	R _n (Ω) ± 10%	U _{op} ≤ (VDC)	U _{max} (VDC)	U _{re} ~ (VDC)	R(Ω) ± 5%
3	8	2.2	3.1	- 0.75	15
5	22	3.7	5.2	- 1.25	47
6	33	4.5	6.3	- 1.50	68
9	74	6,7	9.5	- 2.25	150
12	119	9.0	12	- 3.0	330
16	188	12.0	16	- 4.0	560
18	280	13.5	18	- 4.5	820
24	475	18.0	24	- 6.0	1000
36	1050	27.0	36	- 9.0	2000
48	1750	36.0	48	- 12.0	3900
60	2750	45.0	60	- 15.0	6800

Operative coil voltage range

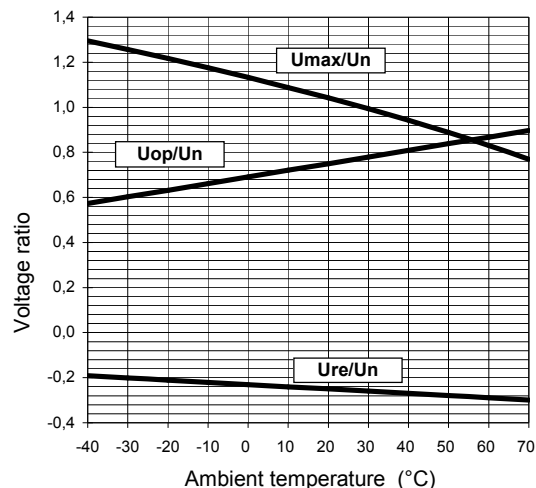
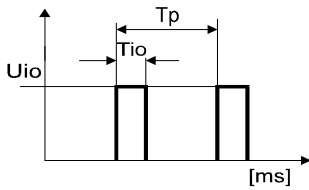

Diagram of voltage range shows that over 30°C of ambient temperature U_{max} for continuous operate duty, which still prevent overheating of the coil, becomes lower then U_n. Therefore, over this temperature, impulse energizing is obligatory, with impulse operate voltage U_{io} ≥ U_n. Impulse coil voltage must not exceed 80% of the test voltage between coil windings.

Impulse energizing



Uio - impulse operate voltage (V)
 Tio - impulse operate duration (ms)
 Tp - periode duration (ms)

Impulse coil voltage for operating Uio can be higher than rated voltage Un, but duration of the operate impulse Tio should be chosen from the following diagram. The best energizing is achieved with rectangular impulse in duration of 20 ms.

Impulse coil voltage for releasing Uir must be opposite polarity as operate coil voltage and can be higher than 45%Un, but duration of release impulse Tir should be chosen from the following diagram, to avoid re-operate of the relay.

When the relay shall be released with rated coil voltage Un, one external resistor R (see excitation data and driving circuits) must be included in release circuit.

Minimum impulse duration for operating

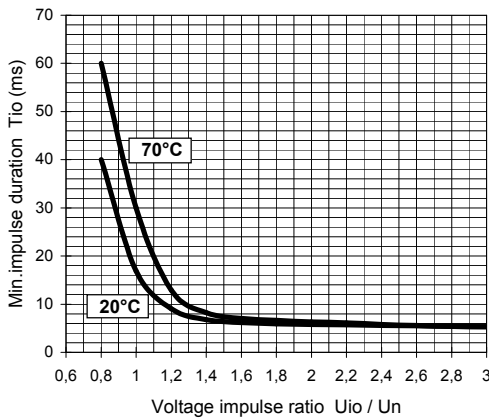

Minimum impulse duration for releasing

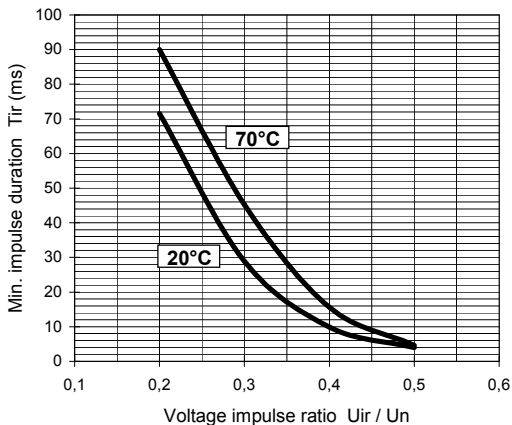

To prevent overheating of the coil at impulse energizing, the operate impulse duration ratio Tio/Tp must not exceed limit regarding to the operate voltage ratio Uio/Un (see the following diagram).

Min.periode duration Tp = 10s for 10A relais and 6s for 7A relais.

Maximum impulse duration ratio for operating

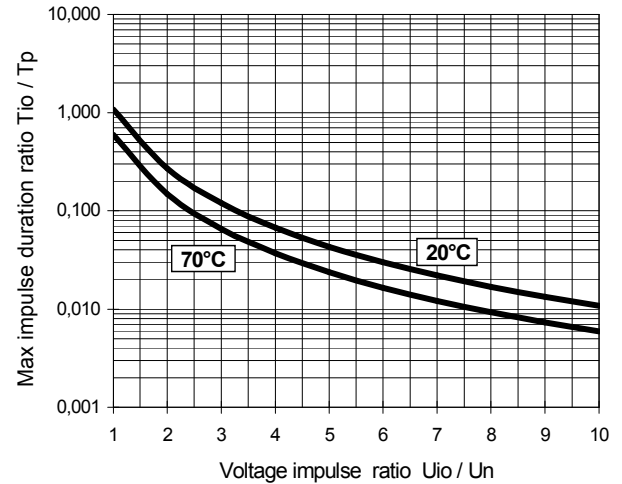

Other data

Test voltage (1 min.)	
contact - coil:	≥ 4 or 2 kV _{rms} , 50 Hz
contact - contact:	≥ 1 kV _{rms} , 50 Hz
Impulse voltage test (1.2/50)μs:	≥ 5 kV _{imp}
Operate time at Un	abt. 5 ms
Release time:	abt. 6 ms
Bounce time:	abt. 5 ms - make, abt. 10 ms - break
Insulation resistance (500 VDC):	> 10 ³ MΩ
Vibration resistance (10-200Hz):	10 gn
Shock resistance (11 ms)	
functional:	10 gn
destructive:	100 gn
Ambient temperature	
for operating:	- 40°C to + 70°C
for storage:	- 40°C to + 85°C
Protection degree:	IP 67, IEC 529
Seal test (1min):	Qc/2, IEC 60068-2-17
Flammability class :	V - 0, UL 94
Mounting position :	optional
Relay weight:	abt. 9.5 g

Max. switching capacity, resistive DC load

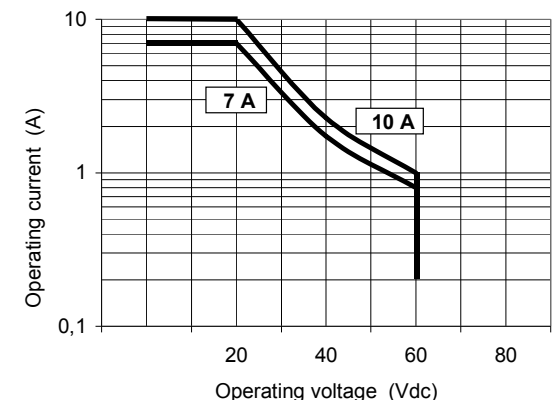

Electrical life, resistive AC load

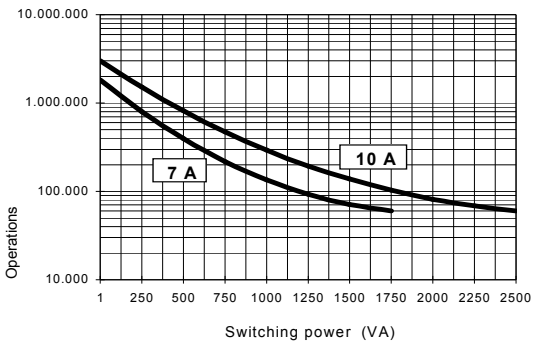

Electrical life, resistive DC load

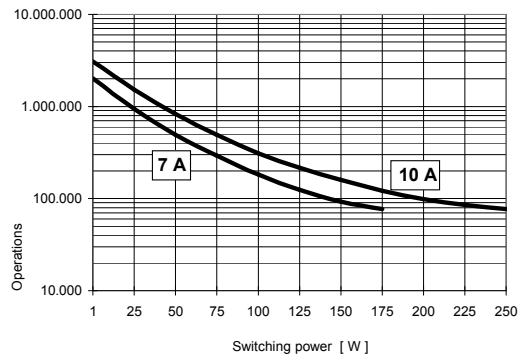

Ordering data

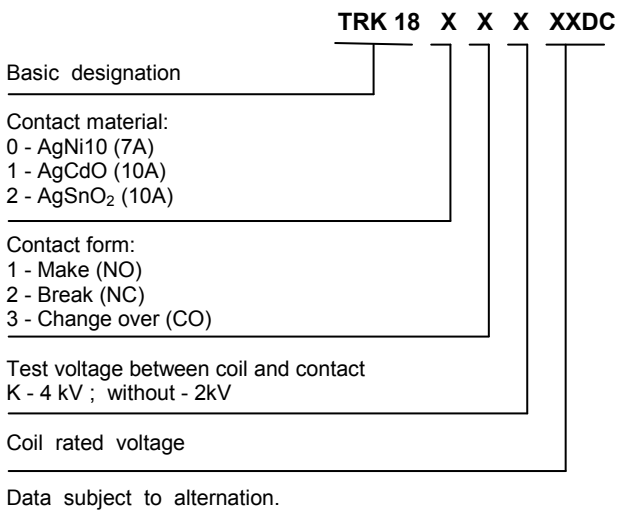

Recommended driving circuit

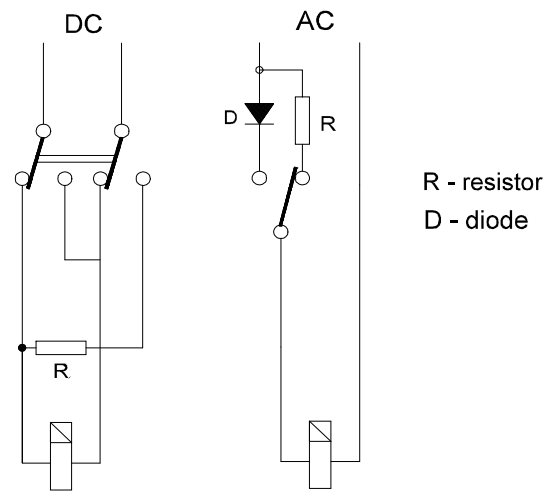

Dimensions and terminals layout

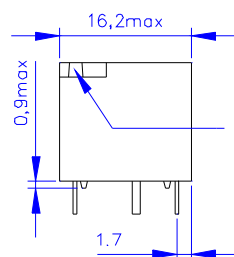
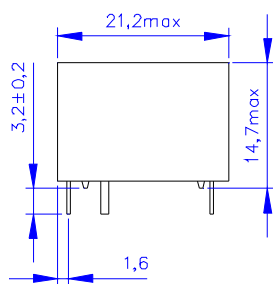

Dimensions in mm
 Tolerances ± 0.1

Terminals side view

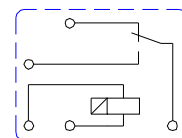
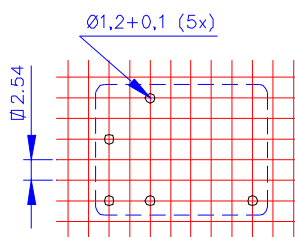
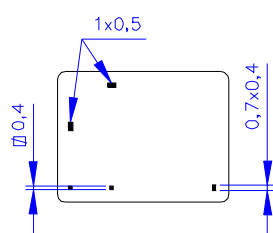

ISKRA-RELEJI d.d.

Štatenberg 88,
SI- 2321 Makole
SLOVENIA

Commercial department

Tel.:+386 2 803 10 20, Fax: +368 2 803 10 21

E-mail: sales@iskra-releji.si

Producer reserves all rights to alter characteristics at any time without notice. Producer assumes no liability for damage to people or things, caused as a result of the incorrect use or application of its products. All Rights Reserved.

© September 2013